

KENWOOD

KVA-S300

AUDIO VIDEO SELECTOR

INSTRUCTION MANUAL

SELECTEUR AUDIO VIDEO

MODE D'EMPLOI

AUDIO-VIDEO-WÄHLER

BEDIENUNGSANLEITUNG

AUDIO-VIDEO-KIEZER

GEBRUIKSAANWIJZING

SELETTORE AUDIO VIDEO

ISTRUZIONI PER L'USO

SELECTOR DE AUDIO VÍDEO

MANUAL DE INSTRUCCIONES

SELECTOR AUDIO VÍDEO

MANUAL DE INSTRUÇÕES

KENWOOD CORPORATION



©B64-2020-10 (W) (DT)

Installation

Safety precautions

▲WARNING

To prevent injury or fire, take the following precautions:





- Insert the unit all the way in until it is fully locked in place. Otherwise it may fall out of place when jolted.
- When extending the ignition, battery, or ground wires, make sure to use automotive-grade wires or other wires with a 0.75mm² (AWG18) or more to prevent wire deterioration and damage to the wire coating.
- If the unit starts to emit smoke or strange smells, turn off the power immediately and consult your Kenwood dealer.

▲CAUTION

To prevent damage to the machine, take the following precautions:

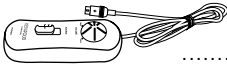
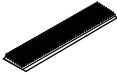
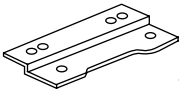
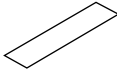
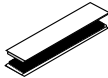
- Make sure to ground the unit to a negative 12V DC power supply.
- Do not open the top or bottom covers of the unit.

Accessories

Part name	External view Number of items	Part name	External view Number of items
① Remote controller (cable length:5m)	2	⑤ Velcro strips (Loop : 25x70mm)	2
② Installation bracket	2	⑥ Double-side adhesive tape	2
③ Velcro strips (20x60mm)	2	⑦ Tapping screw (ø3x6mm)	4
④ Velcro strips (Hook : 12x65mm)	2	⑧ Tapping screw (ø4x12mm)	4

▲CAUTION

The use of any accessories except for those provided might result in damage to the unit. Make sure only to use the accessories shipped with the unit, as shown above.

Installation procedure

1. Remove the ignition key and disconnect the negative ⊖ terminal of the battery to prevent short circuits.
2. Set the unit according to the intended usage.
3. Connect the input and output cables of the units.
4. Connect the Ignition wire and grounding wire following this order.
5. Install the unit in the car.
6. Connect the negative ⊖ terminal of the battery.

▲CAUTION

- Be sure to turn the power off before changing the setting of any switch.
- If the fuse blows, check cables for shorts, then replace the fuse with one of the same rating.
- Check that no unconnected wires or connectors are touching the car body.
- After installation, check that the brake lamps, wipers, and wipers work properly.

Connecting Cables to Terminals (example)

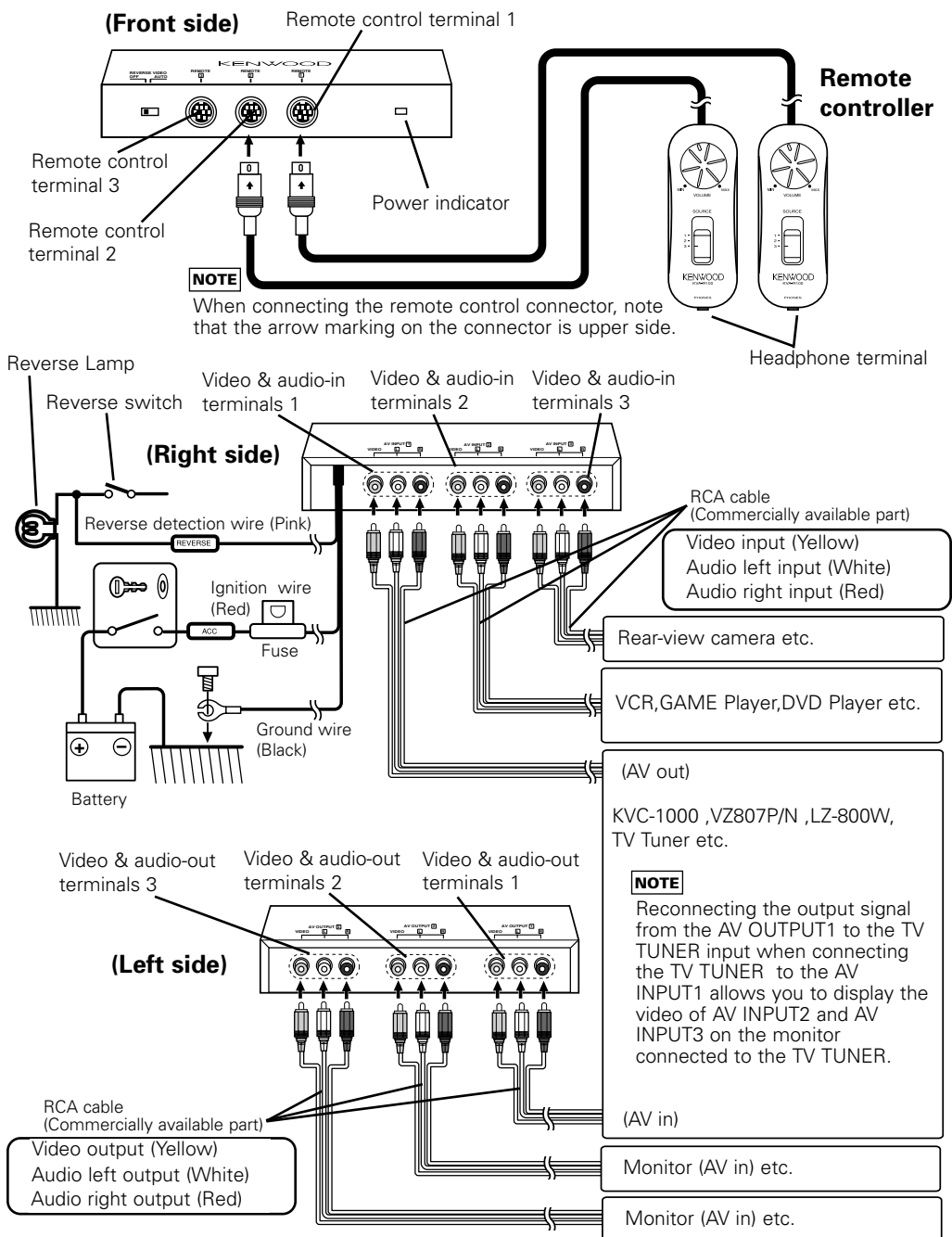

Installation

Installation

■ Securing to audio board

1 Attach the installation brackets to the bottom of the KVA-S300 using the binding screws ($\phi 3 \times 6\text{mm}$).

2 Mount the KVA-S300 to an audio board using the self-tapping screws ($\phi 4 \times 12\text{mm}$).

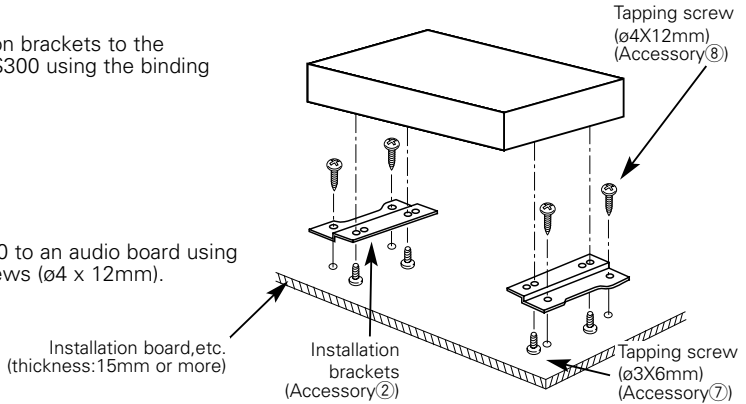

■ Securing to the body of the vehicle

Peel off the protection paper from the Velcro strip (Accessory 3) and paste the one side to the bottom of the KVA-S300 and the other side to the body of the vehicle.

▲ CAUTION

Please do not install the unit near the dashboard, the rear tray, or other important components. Doing so could lead to injury or accident should the unit come off due to a shock and strike a person or an important component.

Tapping screws should be used for mounting. (Attachment with velcro strips, although easy, can come off with a shock.)

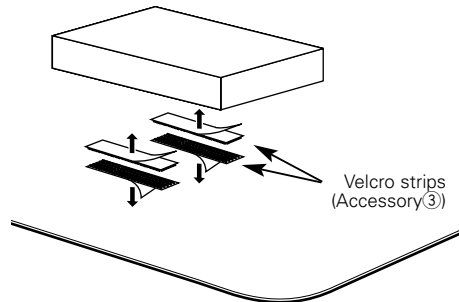

Attaching the remote controller

1 Clean the place where you want to attach the remote controller with a detergent to remove dirt or oil and wipe the surface with a soft dry cloth.

2 Attach the remote controller to the center console or any convenient place using the supplied Velcro strips.

NOTE

If you find that the Velcro strips (Loop: Accessory 5) will not attach to the center console surface, provide the double-sided adhesive tape (Accessory 6) to the Velcro for secure attachment. (Paste the yellow protection paper side to the Velcro strip and the transparent protection paper side to the body of the vehicle.)

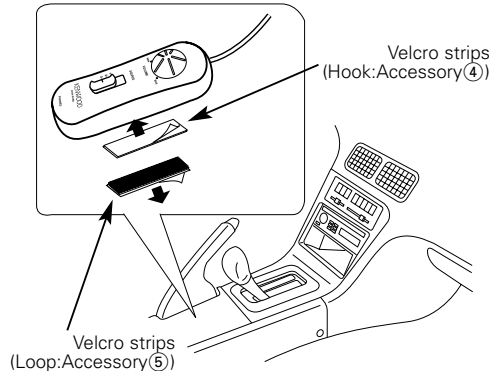

Operation

Operation of remote controller

■ Volume adjustment

Turning clockwise the headphone volume knob on the remote controller increases the sound volume from the headphone and turning counterclockwise decreases the volume.

NOTE

Headphone volume, if minimized, will not be muted.

■ AV-in source switching

If the remote control unit is connected to the remote connection terminal 1, you can select the inputs from AV INPUTs 1, 2 and 3 for the video available from AV OUTPUT1.

Setting the remote control AV-in source control to 1 switches to the AV INPUT1 video, and 2 to the AV INPUT2 and 3 to the AV INPUT3. The same is true with the remote connection terminals 2 and 3.

NOTE

The outputs where no corresponding remote control units are connected are fed with the video images from the AV INPUT1.

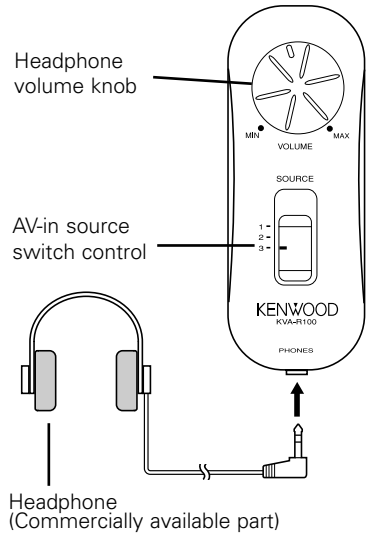

REVERSE VIDEO AUTO/OFF switching

Setting the REVERSE VIDEO AUTO/OFF selector switch to AUTO with the rear-view camera (Commercially available part) connected to the AV INPUT3 allows you to automatically switch the AV OUTPUT1 video alone to the rear-view camera when you put your car into reverse gear.

NOTE

If the KVA-S300 is not connected with the rear-view camera, note that the REVERSE VIDEO AUTO/OFF selector switch be turned off.

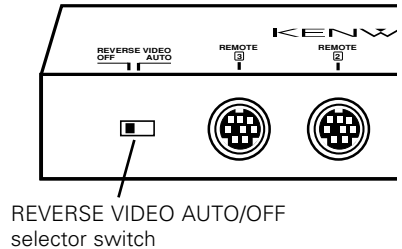

Specifications

Specifications subject to change without notice.

Switching Unit

Weight814 g
Size168(W) x 180.4(H) x 30(D) mm
Video input level (RCA jack)1 Vp-p/75 Ω
Audio input level (RCA jack)1.15 Vrms (22 KΩ)
Video output level (RCA jack)1 Vp-p/75 Ω
Audio output level (RCA jack)1.15 Vrms (1 KΩ)

Controller Unit

Size40(W) x 105(H) x 20.5(D) mm
Weight160 g
Phone jack (Miniplug x 1)	Audio output level
15 mW + 15 mW (32 Ω)

General

Operating voltage14.4 V DC (10.5 to 16 V)
Current Consumption≤300 mA
Input level (Reverse detection wire)2.5 to 16 V